

## Thermally-Enhanced High Power RF LDMOS FET 30 W, 28 V, 2620 – 2690 MHz

### Description

The PTAC260302FC is a 30-watt LDMOS FET intended for use in multi-standard cellular power amplifier applications in the 2620 to 2690 MHz frequency band. This device integrates a 10-W (main) and a 20-W (peak) transistor, making it ideal for asymmetric Doherty amplifier designs. Features include input matching, high gain and thermally-enhanced package with earless flange. Manufactured with Infineon's advanced LDMOS process, this device provides excellent thermal performance and superior reliability.

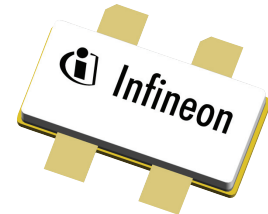

PTAC260302FC  
Package H-37248H-4

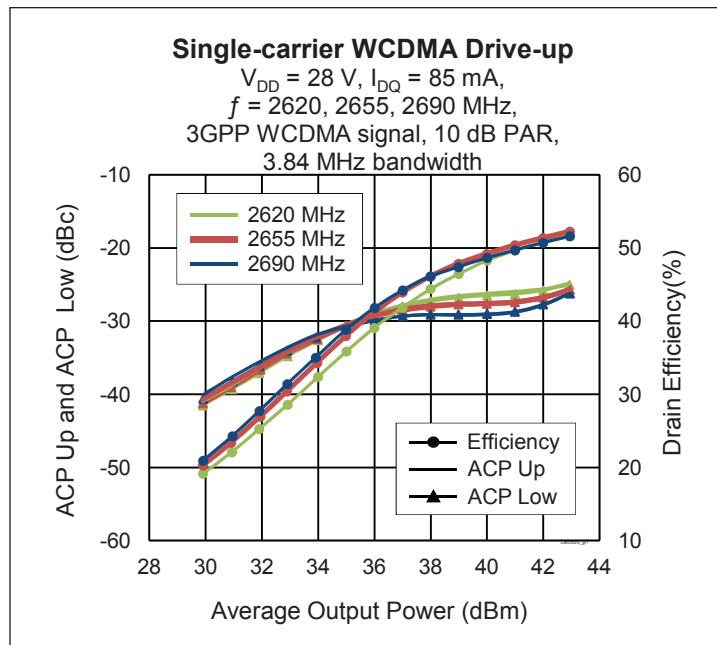

### Features

- Asymmetric design
- Broadband internal matching
- Typical CW performance, 2690 MHz, 28 V (Doherty configuration, combined output)
  - Output power @  $P_{3dB} = 30\text{ W}$
  - Efficiency = 54%
  - Gain = 13 dB
- Typical single-carrier WCDMA performance, 2690 MHz, 28 V, 10 dB PAR
  - Output power = 37.5 dBm avg
  - Gain = 15.5 dB
  - Efficiency = 45%
- Capable of handling 10:1 VSWR @ 32 V, 30 W (CW) output power
- Integrated ESD protection
- Human Body Model Class 1B (per ANSI/ESDA/JEDEC JS-001)
- Pb-free and RoHS compliant

### RF Characteristics

#### Single-carrier WCDMA Specifications (tested in Infineon Doherty test fixture)

$V_{DD} = 28\text{ V}$ ,  $I_{DQ} = 85\text{ mA}$ ,  $V_{GS1} = 1.1\text{ V}$ ,  $P_{OUT} = 5.6\text{ W avg}$ ,  $f = 2690\text{ MHz}$ ,  
 3GPP WCDMA signal, 3.84 MHz channel bandwidth, 10 dB peak/average @ 0.01% CCDF

Characteristic	Symbol	Min	Typ	Max	Unit
Linear Gain	$G_{ps}$	14.5	15.5	—	dB
Drain Efficiency	$\eta_D$	42	45	—	%
Adjacent Channel Power Ratio	ACPR	—	-27	-25	dBc

All published data at  $T_{CASE} = 25^\circ\text{C}$  unless otherwise indicated

ESD: Electrostatic discharge sensitive device—observe handling precautions!

**DC Characteristics** (each side)

Characteristic	Conditions	Symbol	Min	Typ	Max	Unit
Drain-Source Breakdown Voltage	$V_{GS} = 0\text{ V}, I_{DS} = 10\text{ mA}$	$V_{(BR)DSS}$	65	—	—	V
Drain Leakage Current	$V_{DS} = 28\text{ V}, V_{GS} = 0\text{ V}$	$I_{DSS}$	—	—	1	$\mu\text{A}$
	$V_{DS} = 63\text{ V}, V_{GS} = 0\text{ V}$	$I_{DSS}$	—	—	10	$\mu\text{A}$
Gate Leakage Current	$V_{GS} = 10\text{ V}, V_{DS} = 0\text{ V}$	$I_{GSS}$	—	—	1	$\mu\text{A}$
On-State Resistance	(main) $V_{GS} = 10\text{ V}, V_{DS} = 0.1\text{ V}$	$R_{DS(on)}$	—	0.8	—	$\Omega$
	(peak) $V_{GS} = 10\text{ V}, V_{DS} = 0.1\text{ V}$	$R_{DS(on)}$	—	0.6	—	$\Omega$
Operating Gate Voltage	(main) $V_{DS} = 28\text{ V}, I_{DQ} = 0.085\text{ A}$	$V_{GS}$	2	2.7	3.5	V
	(peak) $V_{DS} = 28\text{ V}, I_{DQ} = 0\text{ A}$	$V_{GS}$	0.4	1.1	1.8	V

**Maximum Ratings**

Parameter	Symbol	Value	Unit	
Drain-Source Voltage	$V_{DSS}$	65	V	
Gate-Source Voltage	$V_{GS}$	-6 to +10	V	
Junction Temperature	$T_J$	225	$^{\circ}\text{C}$	
Storage Temperature Range	$T_{STG}$	-65 to +150	$^{\circ}\text{C}$	
Thermal Resistance	(main) $(T_{CASE} 70^{\circ}\text{C}, 30\text{ W CW})$	$R_{qJC}$	1.5	$^{\circ}\text{C/W}$
	(peak) $(T_{CASE} 70^{\circ}\text{C}, 30\text{ W CW})$	$R_{qJC}$	1.7	$^{\circ}\text{C/W}$

**Ordering Information**

Type and Version	Order Code	Package and Description	Shipping
PTAC260302FC V1 R0	PTAC260302FCV1R0XTMA1	H-37248H-4, Ceramic open-cavity, earless	Tape & Reel, 50 pcs
PTAC260302FC V1 R250	PTAC260302FCV1R250XTMA1	H-37248H-4, Ceramic open-cavity, earless	Tape & Reel, 250 pcs

**Pinout Diagram** (top view)



Lead connections for PTAC260302FC

**Typical Performance** (data taken in a production test fixture)

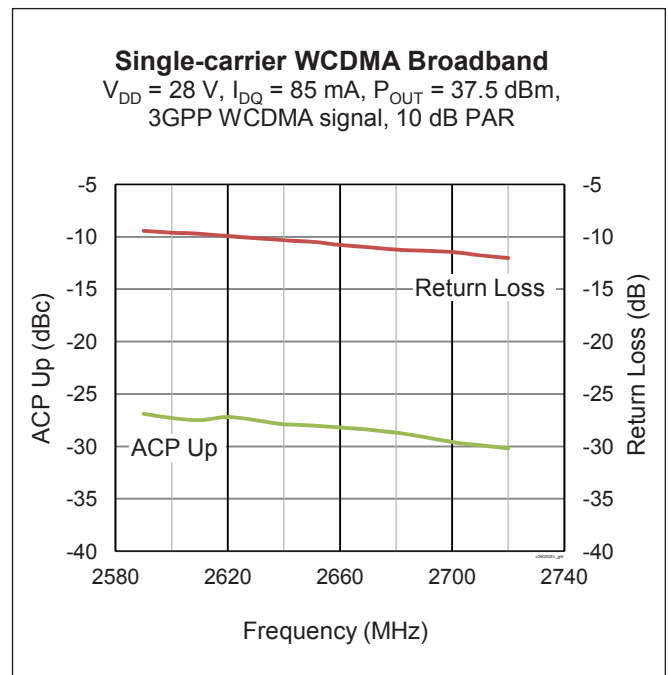
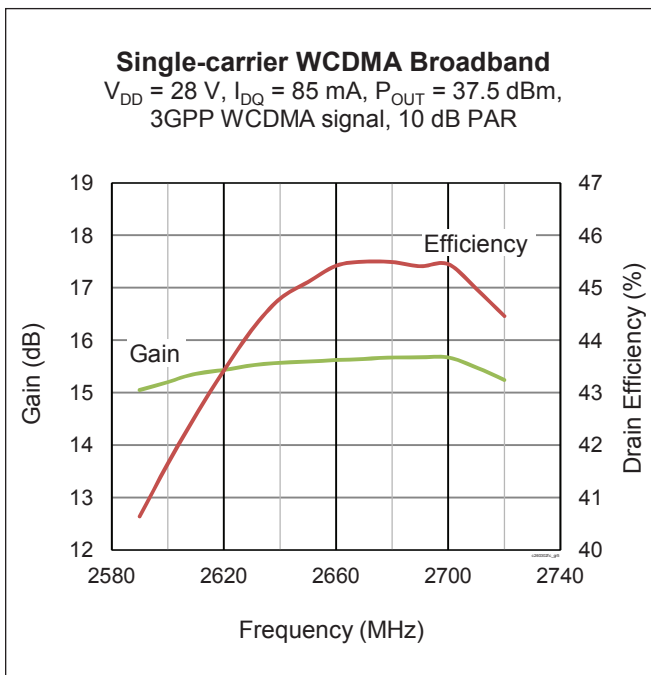

Typical Performance (cont.)

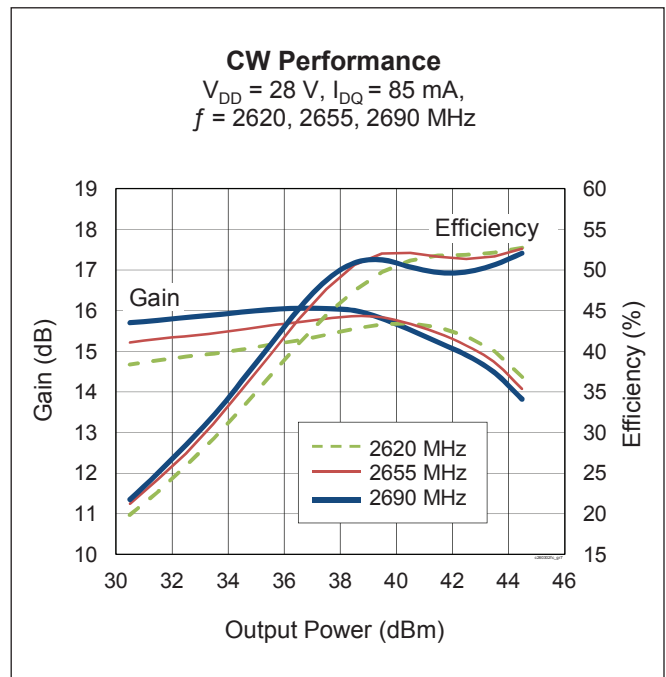
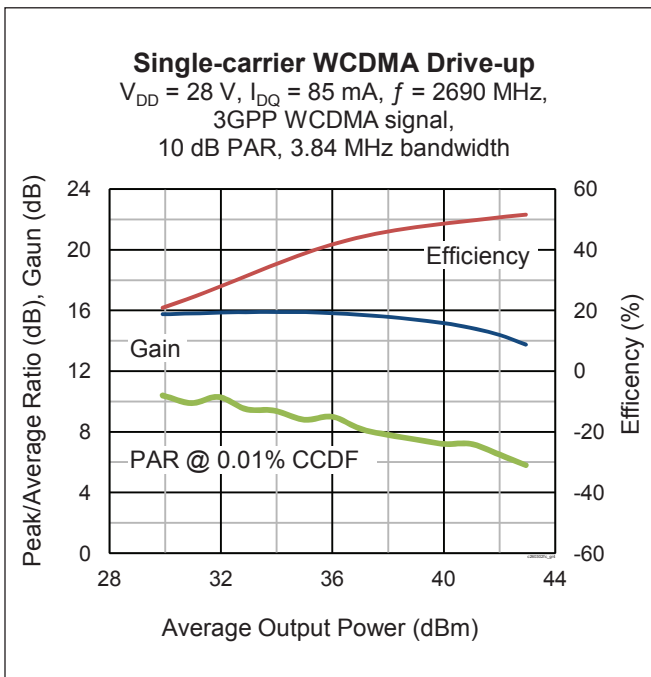
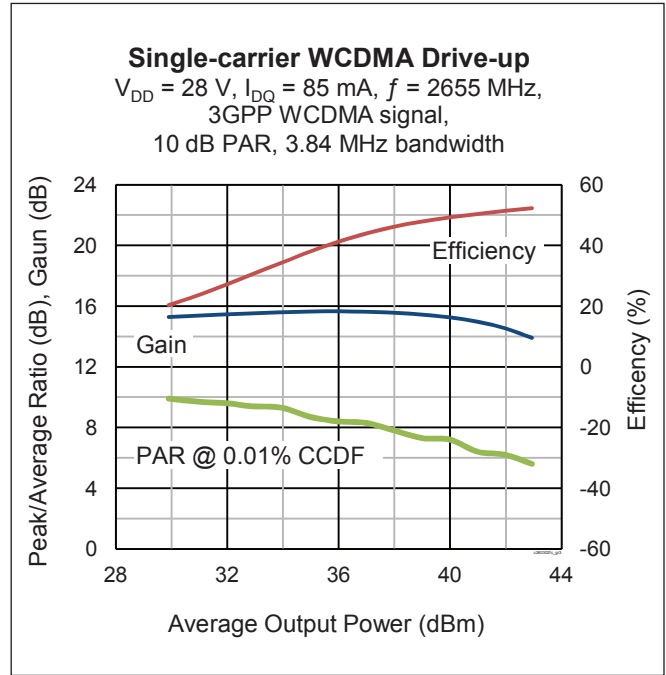
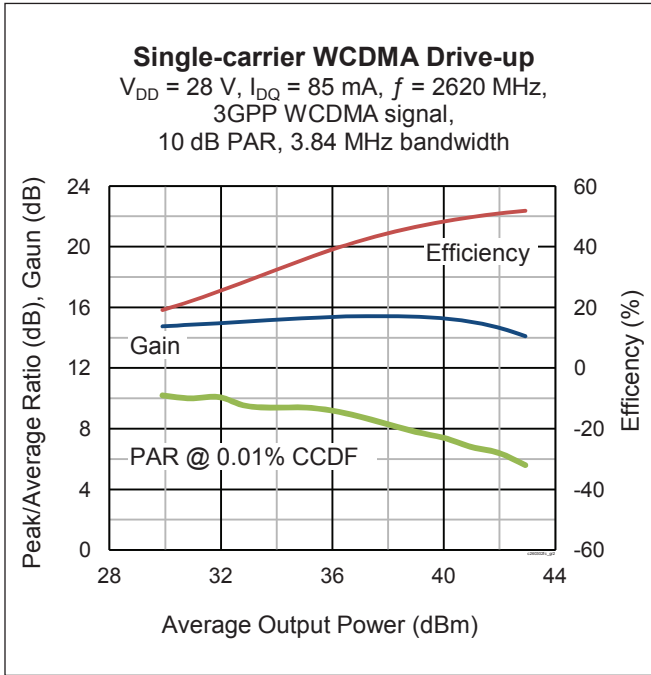

Typical Performance (cont.)

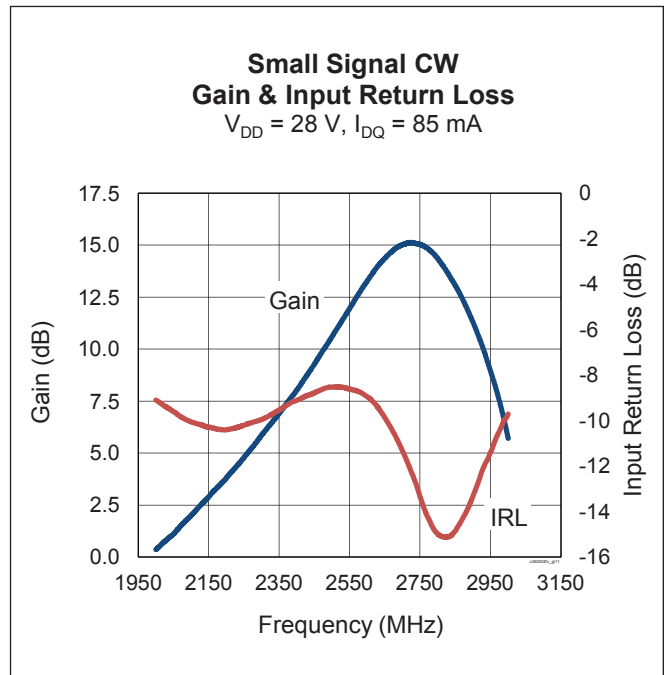
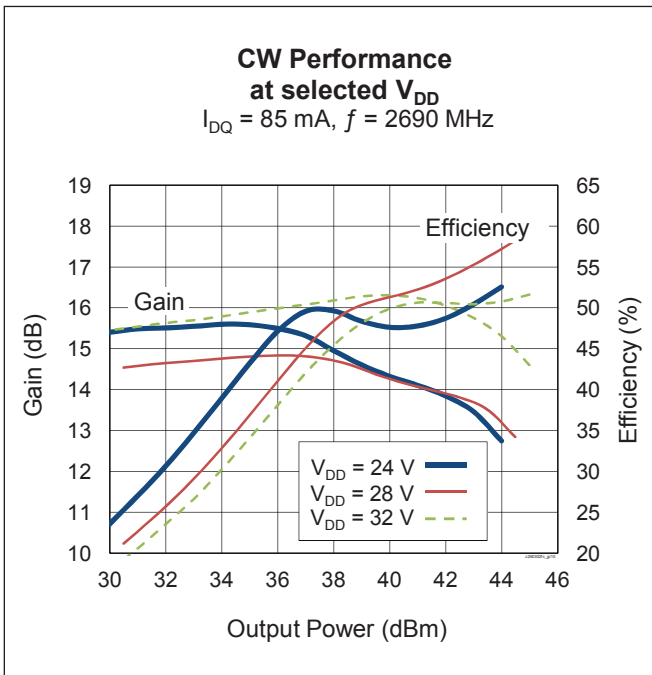
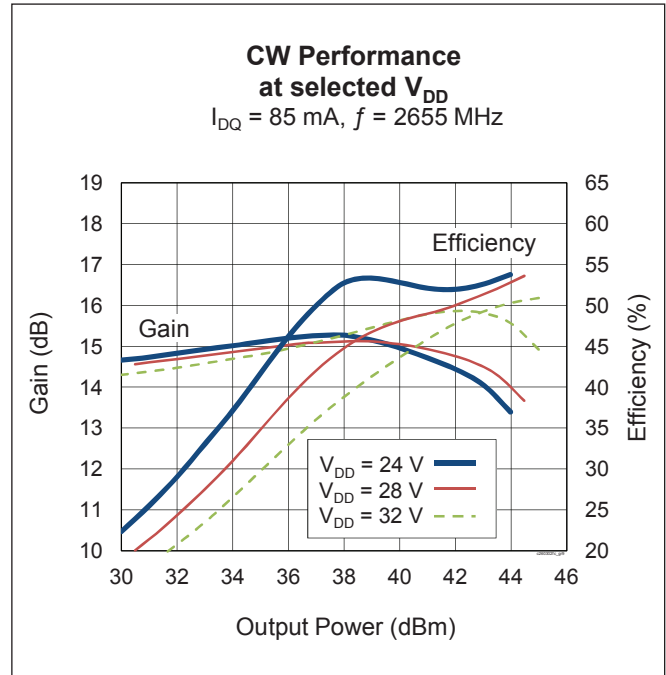
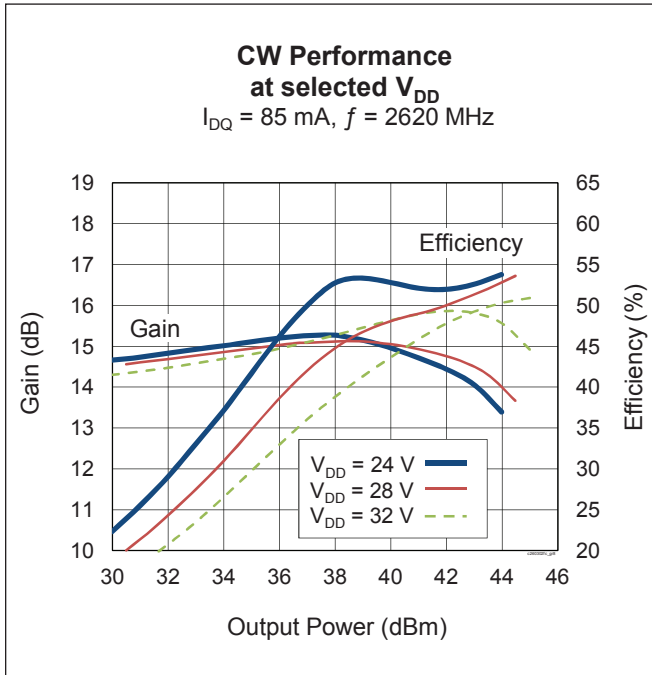

## Load Pull Performance

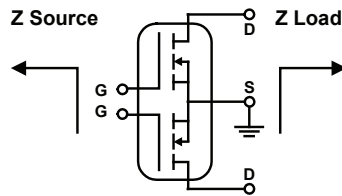

**Main Side** – Pulsed CW signal: 16  $\mu$ sec, 10% duty cycle; 28 V, 85 mA

Class AB		P <sub>1dB</sub>										
		Max Output Power					Max PAE					
Freq [MHz]	Z <sub>s</sub> $\Omega$	Z <sub>l</sub> $\Omega$	Gain [dB]	P <sub>OUT</sub> [dBm]	P <sub>OUT</sub> [W]	PAE %	Z <sub>l</sub> $\Omega$	Gain [dB]	P <sub>OUT</sub> [dBm]	P <sub>OUT</sub> [W]	PAE %	
2620	26 - j22	10.9 - j9.7	19.7	42.36	17.2	61.0	5.9 - j7.0	21.6	40.70	11.7	66.4	
2655	33 - j32	12.7 - j9.6	20.0	42.45	17.6	59.8	7.1 - j8.1	21.4	41.36	13.7	65.9	
2690	55 - j34	15.2 - j11.4	19.3	42.86	19.3	55.1	6.8 - j9.0	21.2	41.33	13.6	64.4	

**Peak Side** – Pulsed CW signal: 16  $\mu$ sec, 10% duty cycle; 28 V, 115 mA

Class AB		P <sub>1dB</sub>										
		Max Output Power					Max PAE					
Freq [MHz]	Z <sub>s</sub> $\Omega$	Z <sub>l</sub> $\Omega$	Gain [dB]	P <sub>OUT</sub> [dBm]	P <sub>OUT</sub> [W]	PAE %	Z <sub>l</sub> $\Omega$	Gain [dB]	P <sub>OUT</sub> [dBm]	P <sub>OUT</sub> [W]	PAE %	
2620	36 - j41	11.5 - j14.9	19.6	43.11	20.5	58.8	6.4 - j13.4	20.9	41.92	15.6	63.9	
2655	42 - j31	11.9 - j12.7	20	43.09	20.4	61.1	7.0 - j13.9	20.8	42.07	16.1	63.2	
2690	55 - j33	12.9 - j15.0	19.5	42.87	19.4	57.2	7.8 - j15.1	20.5	42.16	16.4	61.8	

## Reference Circuit

DUT	PTAC260302FC
Test Fixture Part No.	LTA/PTAC260302FC
PCB	Rogers 4350, 0.762 mm [.030"] thick, 2 oz. copper, $\epsilon_r = 3.66$
Find Gerber files for this test fixture on the Infineon Web site at ( <a href="http://www.infineon.com/rfpower">http://www.infineon.com/rfpower</a> )	

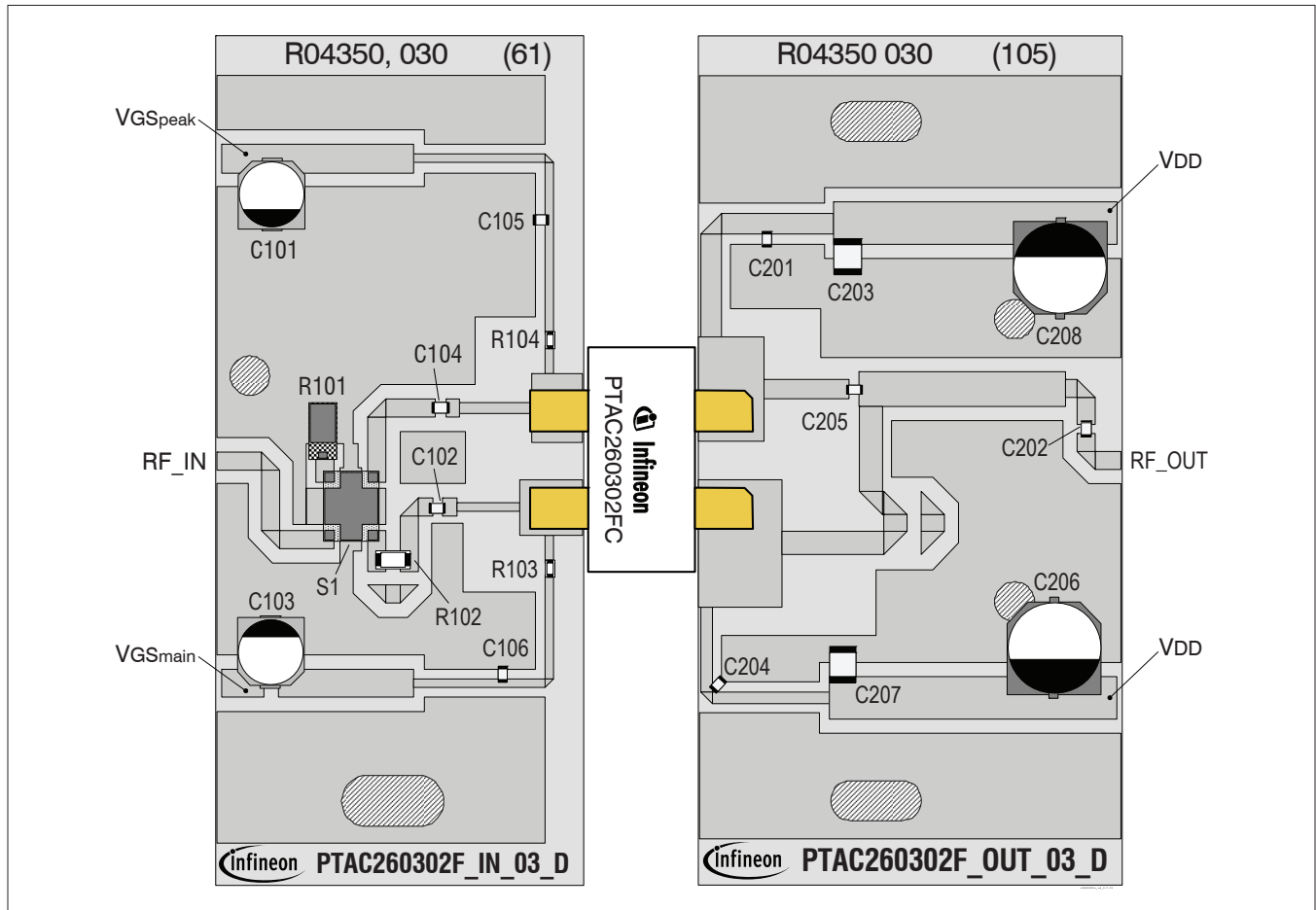
**Reference Circuit** (cont.)

*Reference circuit assembly diagram (not to scale)*
**Component Information**

Component	Description	Suggested Manufacturer	P/N
<b>Input</b>			
C101, C103	Capacitor, 10 $\mu$ F, 50 V	Panasonic Electronic Components	EEV-HD1H100P
C102, C104, C105, C106	Chip capacitor, 18 pF	ATC	ATC100A180JW150XB
R101	Resistor, 50 Ohm	Anaren	C16A50Z4
R102	Resistor, 20 Ohm	Panasonic Electronic Components	ERJ-8GEYJ200V
R103, R104	Resistor, 10 Ohm	Panasonic Electronic Components	ERJ-3GEYJ100V
S1	Hybrid coupler	Anaren	X3C25P1_05S
<b>Output</b>			
C201, C202	Chip capacitor, 18 pF	ATC	ATC100A180JW150XB
C203, C207	Capacitor, 10 $\mu$ F	Taiyo Yuden	UMK325C7106MM-T
C204, C205	Chip capacitor, 18 pF	ATC	ATC100A180JW150XB
C206, C208	Capacitor, 220 $\mu$ F, 35 V	Panasonic Electronic Components	EEE-FP1V221AP

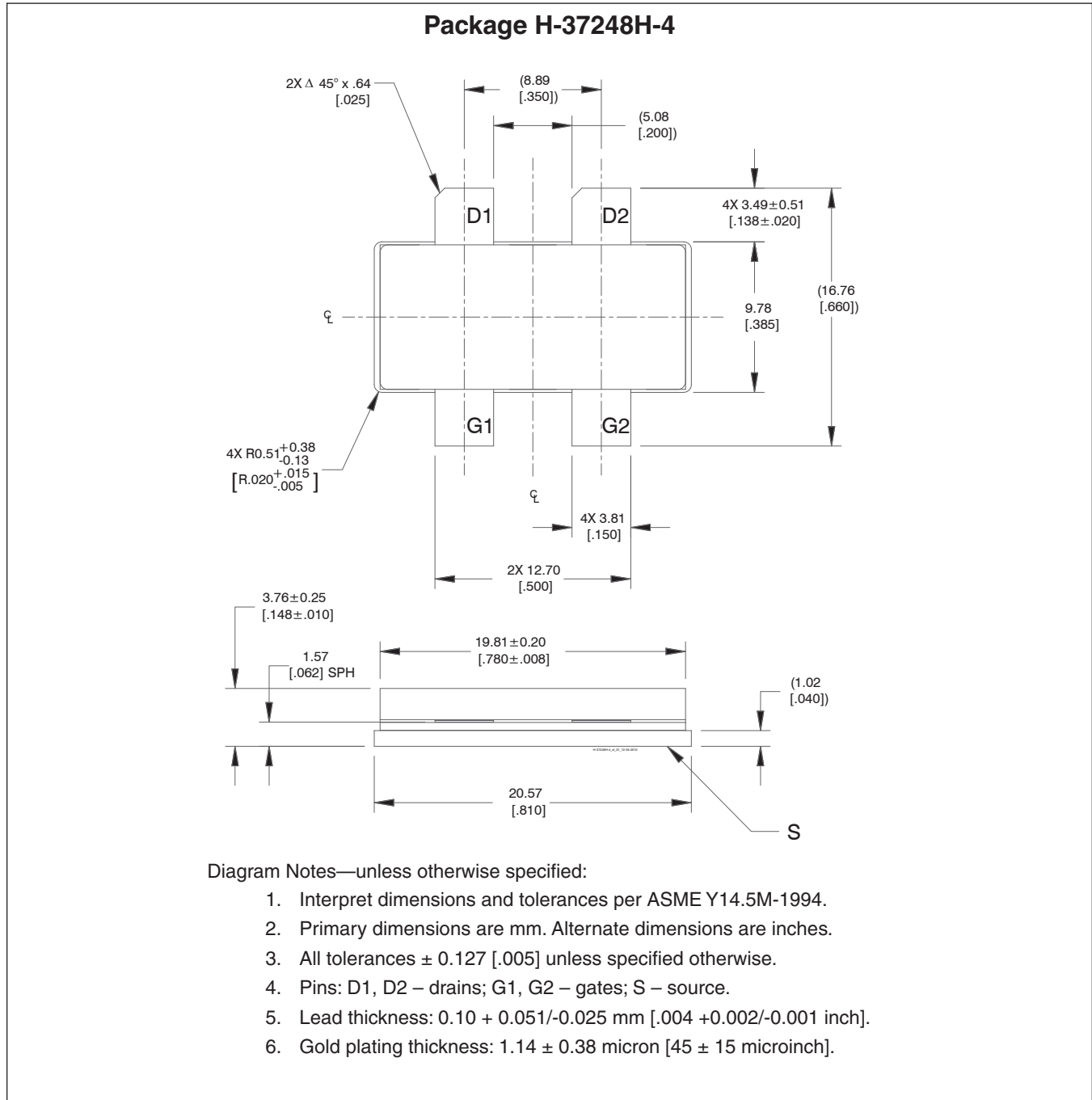
### Package Outline Specifications



Find the latest and most complete information about products and packaging at the Infineon Internet page <http://www.infineon.com/rtpower>



## Revision History

Revision	Date	Data Sheet	Page	Subjects (major changes since last revision)
01	2012-03-05	Advance	all	New product, proposed only.
02	2012-11-28	Advance	1,3 2	Updated package and Package Outline. Updated Pinout Diagram.
03	2014-02-12	Production	all 3 – 7	Product released to production. All information updated. Performance graphs, load pull and circuit information added.
04	2016-06-21	Production	1 2	Updated ESD rating Maximum junction temperature raised to 225°C, updated ordering info.

### We Listen to Your Comments

Any information within this document that you feel is wrong, unclear or missing at all?  
Your feedback will help us to continuously improve the quality of this document.  
Please send your proposal (including a reference to this document) to:

[highpowerRF@infineon.com](mailto:highpowerRF@infineon.com)

To request other information, contact us at:  
+1 877 465 3667 (1-877-GO-LDMOS) USA  
or +1 408 776 0600 International

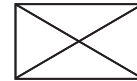

**Edition 2016-06-21**

**Published by  
Infineon Technologies AG  
85579 Neubiberg, Germany**

**© 2012 Infineon Technologies AG  
All Rights Reserved.**

### Legal Disclaimer

The information given in this document shall in no event be regarded as a guarantee of conditions or characteristics. With respect to any examples or hints given herein, any typical values stated herein and/or any information regarding the application of the device, Infineon Technologies hereby disclaims any and all warranties and liabilities of any kind, including without limitation, warranties of non-infringement of intellectual property rights of any third party.

### Information

For further information on technology, delivery terms and conditions and prices, please contact the nearest Infineon Technologies Office ([www.infineon.com/rfpower](http://www.infineon.com/rfpower)).

### Warnings

Due to technical requirements, components may contain dangerous substances. For information on the types in question, please contact the nearest Infineon Technologies Office.

Infineon Technologies components may be used in life-support devices or systems only with the express written approval of Infineon Technologies, if a failure of such components can reasonably be expected to cause the failure of that life-support device or system or to affect the safety or effectiveness of that device or system. Life support devices or systems are intended to be implanted in the human body or to support and/or maintain and sustain and/or protect human life. If they fail, it is reasonable to assume that the health of the user or other persons may be endangered.